

LAMONA

at the heart of the kitchen

Fan Oven

LAM3451



Instructions and Installation

Register 
my appliance

www.howdens.com/appliance-registration

ISSUE v3. 030522



Free 3 year guarantee

Call now¹

Within the UK:

0333 010 0009

Within Republic of Ireland:

01525 5752

Alternatively, visit www.howdens.com/appliance-registration

LAMONA

**3 year guarantee available.
Register your appliance within 90 days²**

By registering your appliance and creating an account, we will keep you up to date with the latest product information and notify you immediately of any important product updates

¹Lines are open Monday to Friday 9am to 5pm. Calls will be charged at your local rate and may be recorded and monitored for training and quality purposes.

²So that in the event of an important product update, or recall, we can contact you.

Register 
my appliance

Welcome

Dear Customer,







Congratulations on your choice of oven.

The user manual will help you use your product quickly and safely.

- Please read this user manual before installing and using the oven.
- Always follow the safety instructions.
- Keep this user manual within easy reach for future reference.
- Register your appliance to access a digital copy of your user manual for future reference.
- Please read any other documents supplied with the product.

Explanation of symbols





Throughout this manual the following symbols are used.

	Warning for possible hazards to health and property.
	Warning possibility of an electric shock.
	Warning of risk of fire.
	Warning of hot surfaces.
	Important information or useful usage tips.
	Read the user manual.

Contents

1. Safety instructions	5	4. First use	19
Purpose of usage	5	First cleaning	19
Child, vulnerable person and pet safety	6	5. How to operate the oven	20
Electrical safety	6	General information on oven usage	20
Transportation safety	7	Operation of the oven control unit	20
Installation safety	8	6. General information about cooking	22
Safety of use	8	General warnings about cooking in the oven	22
Temperature warnings	8	Pastries and oven food	22
Accessory use	9	Meat, fish and poultry	25
Cooking safety	9	Grill	26
Maintenance and cleaning safety	10	7. Maintenance and care	27
General warnings about cooking in the oven	11	General cleaning information	27
2. Environmental instructions	12	Cleaning the accessories	29
Waste regulation	12	Cleaning the control panel	29
Package information	12	Cleaning the inside of the oven (cooking area)	29
Future transportation	12	Cleaning the oven door	29
3. Your product	13	Removing the inner glass of the oven door	30
Product introduction	13	Cleaning the oven lamp	31
Product control panel introduction and usage	14	Replacing the oven lamp	31
Oven control	14	8. Troubleshooting	33
Oven operating functions	15	9. Your guarantee	34
Product accessories	16		
Use of product accessories	17		
Technical specifications	18		

1. Safety instructions

- This section contains safety instructions that will help prevent any risks of personal injuries or material damage.
- If the product is transferred to another person or used second hand, the operating manual, product labels, other relevant documents and accessories should be delivered with the product.
- Our company shall not be held responsible for any damage that may occur as a result of failure to comply with these instructions.
- Failure to comply with these instructions shall render any warranty void.
-  Always have the installation and repair work performed by the manufacturer, the Authorised Service or a person specified by the importer.
-  Use genuine spare parts and accessories only.
-  Do not attempt to repair or replace any part of the product unless it is clearly specified in the operating manual.
-  Do not perform technical modifications on the product.

Purpose of usage

- This product is designed for home use. It is not suitable for commercial use.
- Do not use the product in gardens, balconies or other outdoor environments. The appliance is intended to be used in household and staff kitchen areas in shops, offices and other working environments.
- **WARNING:** This product should be used for cooking purposes only. It should not be used for different purposes, such as heating the room.
- The oven can be used to defrost, bake, fry and grill food.
- This product; should not be used for heating, plate heating, hanging towels or clothes on the handle for drying.

Child, vulnerable person and pet safety

- This product can be used by children 8 years of age and older, and people who are underdeveloped in physical, sensory or mental skills, or lack of experience and knowledge, as long as they are supervised or trained about the safe use and hazards of the product.
- Children should not play with the product. Cleaning and user maintenance should not be performed by children unless there is someone overseeing them.
- This product should not be used by people with limited physical, sensory or mental capacity (including children), unless they are kept under supervision or receive the necessary instructions.
- Children should be supervised to ensure that they do not play with the product.
- Electrical products are dangerous for children and pets. Children and pets must not play with, climb on, or enter the product.
- Do not put objects that children may reach on the product.
- **WARNING:** During use, the accessible surfaces of the product are hot. Keep children away from the product.
- Keep the packaging materials out of the reach of children. There is a hazard of injury and suffocation.
- When the door is open, do not put any heavy objects on it or allow children to sit on it. You may cause the oven to tip over or damage the door hinges.
- For the safety of children, disconnect the power cable and make the product inoperable before disposing of the product.

Electrical safety

- Wire the product into a grounded outlet protected by a fuse that matches the current ratings indicated on the type label. Have the grounding installation made by a qualified electrician. Do not use the product without grounding in accordance with local / national regulations. The electrical connection of the product should be in an easily accessible place (where it will not be affected by the flame of the stove). If this is not possible, there should be a mechanism (fuse, switch, etc.) on the electrical installation to which the product is connected, in compliance with the electrical regulations and separating all poles from the network.
- The product must not be wired into the outlet during installation, repair, and transportation.

- Do not wire the product into an outlet that is loose, has come out of its socket, is broken, dirty, oily, with risk of water contact (for example, water that may leak from the counter).
- Never touch the electrical connection with wet hands! To remove appliance, do not pull the cord.
- Make sure that the product is securely wired into the outlet to avoid arcing.
- Wire the product into an outlet that meets the voltage and frequency values specified on the type label.
- Do not jam the power cord under and behind the product. Do not put a heavy object on the power cord. The power cord should not be bent, crushed, and come into contact with any heat source.
- While the oven is operating, its back surface also gets hot. Power cords must not touch the back surface, connections may be damaged.
- Do not jam the electric cables into the oven door and pass them over hot surfaces. You may cause the oven to short circuit and catch fire as a result of the cable melting.
- Use original cable only. Do not use cut or damaged cables or extension leads.
- If the power cord is damaged, it must be replaced by a manufacturer, an Authorised Service or a person to be specified by the importer company in order to prevent possible dangers.
- **WARNING:** Before replacing the oven lamp, be sure to disconnect the product from the mains supply to avoid the risk of an electric shock. Disconnect the product or turn off the fuse from the fuse box.

Transportation safety

- Disconnect the product from the mains before transporting the product.
- The product is heavy, carry the product with at least two people.
- Do not use the door and / or handle to transport or move the product.
- Do not put other items on the product and carry the product upright.
- When you need to transport the product, wrap it with bubble wrap packaging material or thick cardboard and tape it tightly. Secure the product tightly with tape to prevent the removable or moving parts of the product and the product from damage.
- Check the overall appearance of the product for any damage that may have occurred during transportation.

Installation safety

- Before the product is installed, check the product for any damage. If the product is damaged, do not install it.
- Do not install the product near heat sources (radiators, stoves, etc.).
- Keep all ventilation ducts open around the product.
- To prevent overheating, the product should not be installed behind decorative doors.

Safety of use

- Make sure that the product is turned off after each use.
- If you do not use the product for a long time, disconnect it or turn off the fuse from the fuse box.
- Do not operate defective or damaged product. If any, disconnect the electricity / gas connections of the product and call the Authorised Service.
- Do not use the product with the front door glass removed or broken.
- Do not climb on the product to reach anything or for any other reason.
- Do not use the product in situations that may affect your judgment, such as drug intake and / or alcohol use.
- Flammable objects kept in the cooking area may catch fire. Never store flammable objects in the cooking area.
- The oven handle is not a towel dryer. When using the product, do not hang towels, gloves or similar textiles.
- The hinges of the product door move and tighten when opening and closing the door. When opening / closing the door, do not hold the part with the hinges.

Temperature warnings

- **WARNING:** While the product is operating, exposed parts will be hot. Do not touch the product and heating elements. Children under the age of 8 should not be brought close to the product without an adult.
 - Do not place flammable / explosive materials near the product, as the edges will be hot while it is operating.
 - As steam may be exhaled, keep away while opening the oven door. The steam may burn your hand, face and / or eyes.
 - The product may be hot during use. Do not touch the hot compartments, the interior parts of the oven, the heating elements, etc.
 - When placing food in the hot oven, removing the food, etc. always use heat resistant oven gloves.
-

Accessory use

- It is important that the wire grill and tray are placed properly on the wire shelves. For detailed information, refer to the section “Usage of accessories”.
- Accessories can damage the door glass when closing the product door. Always push the accessories to the end of the cooking area.

Cooking safety

- Be careful when using alcohol in your food. Alcohol evaporates at high temperatures and may catch fire when exposed to hot surfaces, causing a fire.
- Food waste, oil, etc. in the cooking area may catch fire. Before cooking, remove such coarse dirt.
- Food Poisoning Hazard: Do not keep food in the oven for more than an hour before and after cooking. Otherwise it may cause food poisoning or diseases.
- Do not heat closed tin cans and glass jars. Built-up pressure may cause the jar to burst.
- Place the greaseproof paper in a cookware or on the oven accessory (tray, wire grill, etc.) with food and place it in the preheated oven. Remove any excessive pieces of greaseproof paper hanging from the accessory or container to avoid the risk of touching the oven heating elements. Never use greaseproof paper at an oven temperature higher than the maximum use temperature specified on the greaseproof paper you are using. Never place greaseproof paper on the oven base.
- **Do not place baking trays, plates or aluminium foil directly on the bottom of the oven. The accumulated heat can damage the base of the oven.**
- Close the oven door during grilling. Hot surfaces may cause burns!
- Food not suitable for grilling carries a fire hazard. Grill only food that is suitable for heavy grill fire. Also, do not place the food too far in the back of the grill. This is the hottest area and fatty foods may catch fire.



Maintenance and cleaning safety

- Wait for the product to cool before cleaning the product.
Hot surfaces may cause burns!
- Never wash the product by spraying or pouring water on it!
There is an electric shock hazard!
- Do not clean the product with steam cleaners as this may cause an electric shock.
- Do not use harsh abrasive cleaners, metal scrapers, wire wool or bleach materials to clean the oven front door glass / (if present) oven upper door glass. These materials can cause glass surfaces to be scratched and broken.

General warnings about cooking in the oven



WARNING! Risk of fire!

- Do not place aluminium foil or baking trays on the base of the oven when in use. Heat is reflected downwards and can damage the oven and the cabinets beneath.
- Do not line the grill tray or any baking trays with aluminium foil. The reflected heat can damage the heater.



2. Environmental instructions

Waste regulation

Disposing of the old product. Compliance with the WEEE Directive and disposing of the waste product:

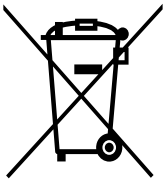

This product complies with EU WEEE Directive (2012/19/EU). This product bears a classification symbol for waste electrical and electronic equipment (WEEE).

This product has been manufactured with high quality parts and materials which can be reused and are suitable for recycling. Do not dispose of the waste product with normal domestic and other wastes at the end of its service life. Take it to the collection centre for the recycling of electrical and electronic equipment. Please consult your local authorities to learn about these collection centres. Appropriate disposal of used appliance helps prevent potential negative consequences for the environment and human health.

Compliance with RoHS Directive:

The product you have purchased complies with EU RoHS Directive (2011/65/EU). It does not contain harmful and prohibited materials specified in the Directive.

Package information

- Packaging materials of the product are manufactured from recyclable materials in accordance with our National Environment Regulations. Do not dispose of the packaging materials together with the domestic or other wastes. Take them to the packaging material collection points designated by the local authority.

Future transportation

- Keep the product's original carton and transport the product in it. Follow the instructions on the carton. If you do not have the original carton, pack the product in bubble wrap or thick cardboard and tape it securely.



Check the general appearance of your product for any damages that might have occurred during transportation.

3. Your product

Product introduction

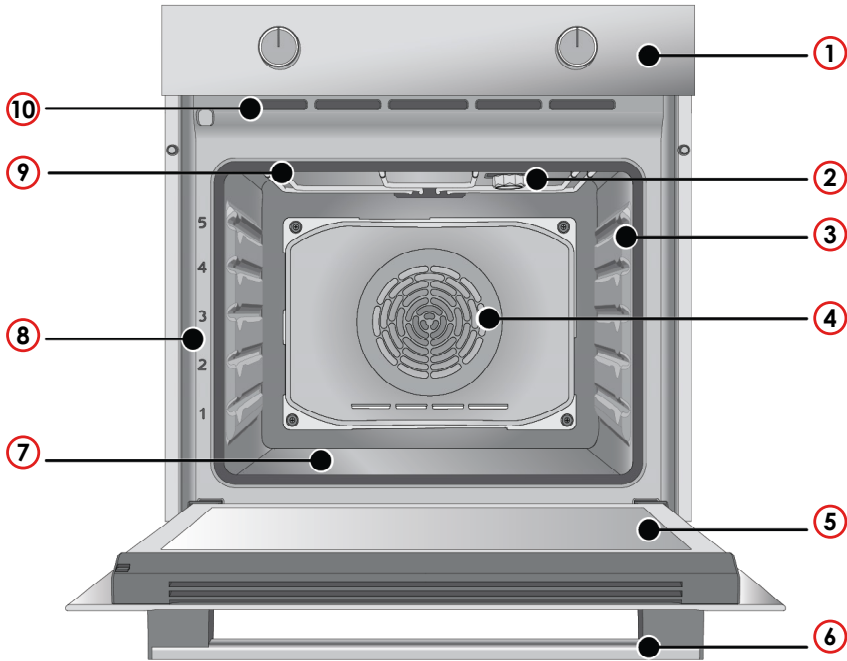

① Control panel

② Lamp*

③ Shelves

④ Fan motor
(behind steel plate)

⑤ Door

⑥ Handle

⑦ Bottom heater
(bottom steel plate)

⑧ Shelf positions

⑨ Top heater

⑩ Ventilation holes

* It depends on the model. Your product may not have a lamp, or the type and location of the lamp may differ from the illustration.

Product control panel introduction and usage

In this section, you can find the overview and basic uses of the product's control panel. There may be differences in images and some features depending on the type of product.

Oven control



① Function selection knob

② Temperature knob

③ Thermostat lamp

Function selection knob

You can select the oven operating functions with the function selection knob. Turn left / right from closed (top) position to select.

Function selection knob





You can select the temperature you want to cook with the temperature knob. Turn clockwise from the closed (top) position to select.

Temperature indicator

You can understand the oven interior temperature from the temperature lamp. The temperature lamp is located on the control panel. The temperature lamp turns on when the product starts, and the temperature lamp turns off when it reaches the set temperature. When the temperature inside the oven drops below the set temperature, the temperature lamp turns on again.

Oven operating functions

On the function table; the operating functions you can use in your oven and the highest and lowest temperatures that can be set for these functions are shown. The order of the operating modes shown here may differ from the arrangement on your product.

Function symbol	Function description	Temperature range (°C)	Description and use
	Oven lamp	*	No heater works in the oven. Only the oven lamp lights up.
	Operating with fan	*	The oven is not heated. Only the fan (on the back wall) operates. Frozen food with granules is slowly defrosted at room temperature, cooked food is cooled. The time required to thaw a whole piece of meat is longer than the food with grains.
	Fan heating	*	The hot air heated by the fan heater is distributed equally and rapidly throughout the oven with the fan. It is suitable for multi-tray cooking of your food at different shelf levels.
	Full grill	*	The large grill on the oven ceiling works. It is suitable for grilling in large amounts.
	Fan assisted full grill	*	The hot air heated by the large grill is quickly distributed into the oven with the fan. It is suitable for grilling in large amounts.

* Your product operates in the temperature range specified on the temperature knob.

Product accessories

i There are various accessories in your product. In this section, the description of the accessories and the descriptions of the correct usage are available.

NOTICE: The trays in your product may be deformed by the effect of the temperature. This has no effect on the function. Deformation disappears when the tray cools down.

1. Standard tray

It is used for pastries, frozen foods and frying large pieces.

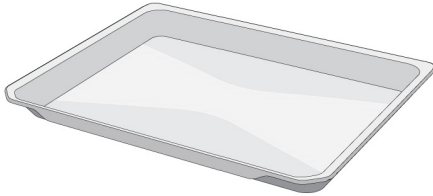

2. Wire grill

It is used for frying or placing the food to be baked, fried and stewed on the desired shelf.

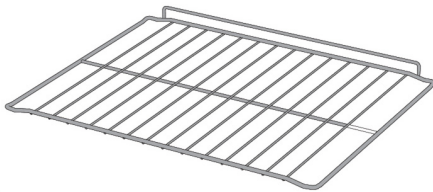

3. Wire grill in tray

By placing it in the tray (if provided), it is ensured that the oils flowing while grilling are collected in the tray and thus the contamination of the oven is prevented.

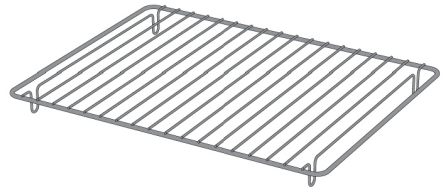

Use of product accessories

Cooking shelves

There are 5 levels of shelf position in the cooking area. You can also see the order of the shelves in the numbers on the front frame of the oven.

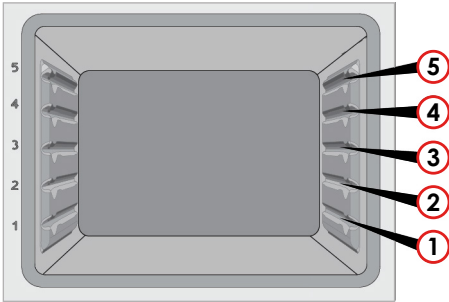

Placing the wire grill on the cooking shelves

It is crucial to place the wire grill on the side shelves properly. The wire grill has one direction when placing it on the shelf. While placing the wire grill on the desired shelf, the open section must be on the front.

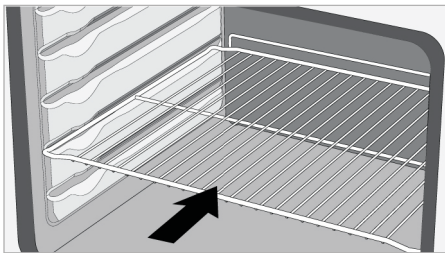

Placing the tray on the cooking shelves

It is also crucial to place the trays on the side shelves properly. The tray has one direction when placing it on the shelf. While placing the tray on the desired shelf, its side designed for holding must be on the front.

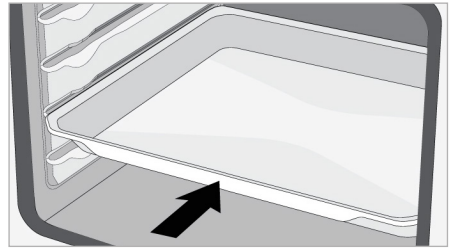

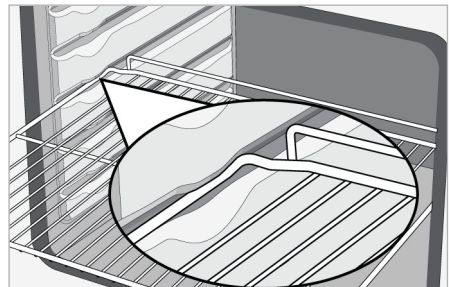

Stopper function of the wire grill

There is a stopper function to prevent the wire grill from tipping out of the wire shelf. With this function, you can easily and safely take out your food. While removing the wire grill, you can pull it forward until it reaches the stopper. You must pass over the stopper to remove it completely.



Technical specifications	
General	
Product external dimensions (height / width / depth)	595mm / 594mm / 567mm
Oven installation dimensions (height / width / depth)	590 or 600mm / 560mm / min. 550mm
Voltage / frequency	220-240 V ~ 50 Hz
Cable type and cross section used / suitable for use in the product	Min. H05VV-FG 3 x 1.5 mm ²
Total power consumption	2.3 kW
Inner lamp type (A)	240 V / 15-25 W / E14 SES / T 300°C
Inner lamp type (B)	25 W, G9, 300°C
Fuse	13A
Oven type	Fan oven

Basics: Information on the energy label of electrical ovens is given in accordance with the EN 60350-1 / IEC 60350-1 standard. Those values are determined under standard load with bottom-top heater or fan assisted heating (if any) functions. Energy efficiency class is determined in accordance with the following prioritisation depending on whether the relevant functions exist on the product or not. 1-Eco fan heating, 2-Fan Heating, 3-Fan assisted low grill, 4-Top and bottom heating.

-  Technical specifications may be changed without prior notice to improve the quality of the product.
-  Figures in this manual are schematic and may not exactly match your product.
-  Values stated on the product labels or in the documentation accompanying it are obtained in laboratory conditions in accordance with relevant standards. Depending on operational and environmental conditions of the product, these values may vary.

4. First use

Before you start using your product, it is recommended to do the following in the following sections.

First cleaning

1. Remove all packaging materials.
2. Remove all accessories from the oven provided within the product.
3. Turn the product on for 30 minutes and then, turn it off. This way, residues and layers that may have remained in the oven during production are burned and cleaned.
4. When operating the product, select the highest temperature and the operating function that all the heaters in your product operate. See "Oven operating functions". You can learn how to operate the oven in the following section.
5. Wait for the oven to cool.
6. Wipe the surfaces of the product with a wet cloth or sponge and dry with a cloth.

Before using the accessories;

Clean the accessories you remove from the oven with detergent water and a soft cleaning sponge.

NOTICE: The surface might get damaged by some detergents or cleaning materials. Do not use aggressive detergents, cleaning powders/creams or any sharp objects during cleaning.

NOTICE: Smoke and smell may emit for a couple of hours during the initial operation. This is quite normal. Ensure that the room is well ventilated to remove the smoke and smell. Avoid directly inhaling the smoke and the smell that emits.

5. How to operate the oven

General information on oven usage

Cooling fan

Your product has a cooling fan. The cooling fan is activated automatically when necessary and cools both the front of the product and the furniture. It is automatically deactivated when the cooling process is finished. Hot air comes out over the oven door. Do not cover these ventilation openings with anything. Otherwise, the oven may overheat.

The cooling fan continues to operate during oven operation or after the oven is turned off (approximately 20-30 minutes). If you cook by programming the oven timer, at the end of the cooking time, the cooling fan turns off with all functions. The cooling fan running time cannot be determined by the user. It turns on and off automatically. This is not an error.

Oven lighting

The oven lamp is turned on when the oven starts cooking. In some models, the lamp is on during cooking, while in some models it turns off after a certain time.

If you want the oven lamp to be lit continuously, select the "Oven lamp" operating function with the function selection knob.

Operation of the oven control unit

Turning on the oven

When you select a operating function you want to cook with using the function selection knob and set a certain temperature with using the temperature knob, the oven starts operating.

Turning off the oven

You can turn the oven off by turning the function selection knob and temperature knob to the off (up) position.

Selecting the temperature and oven operating function

You can cook by making the manual control (under your control) by selecting the temperature and operating function specific to your food.

Example:

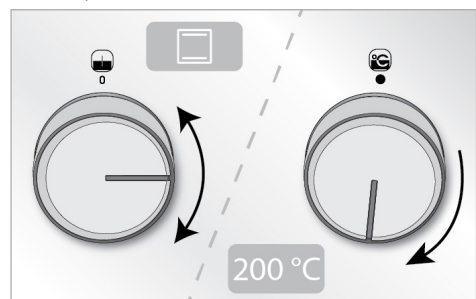

1. Select the operating function you want to cook using the function selection knob.
 2. Set the temperature you want to cook using the temperature knob.
- » Your oven will start operating immediately at the selected function and temperature, and the temperature lamp will light up. When the temperature inside the oven reaches the set temperature, the temperature lamp turns off. The oven does not switch off automatically after starting cooking. You have to control cooking yourself and turn it off. When your cooking is completed, turn off the oven by turning the function selection knob and the temperature knob to the off (up) position.

6. General information about cooking

This section describes tips on preparing and cooking your food.

In addition, you can also find some of the foods tested as producers and the most appropriate settings for these foods. Appropriate oven settings and accessories for these foods are also indicated.

General warnings about cooking in the oven

- While opening the oven door during or after cooking, hot-burning steam may emerge. The steam may burn your hand, face and / or eyes. When opening the oven door, stay away.
- Intense steam generated during cooking may form condensed water drops on the interior and exterior of the oven and on the upper parts of the furniture due to the temperature difference. This is a normal and physical occurrence.
- The cooking temperature and time values given for foods may vary depending on the recipe and amount. For this reason, these values are given as ranges.
- Always remove unused accessories from the oven before you start cooking. Accessories that will remain in the oven may prevent your food from being cooked at the correct values.
- For foods that you will cook according to your own recipe, you can reference similar foods given in the cooking tables.
- Using the supplied accessories ensures you get the best cooking performance. Always observe the warnings and information provided by the manufacturer for the external cookware you will use.
- Cut the greaseproof paper you will use in your cooking in suitable sizes to the container you will cook. Greaseproof papers that are overflowing from the container can create a risk of burns and affect the quality of your cooking. Use the greaseproof paper you will use in the temperature range specified.
- For good cooking performance, place your food on the recommended correct shelf. Do not change the shelf position during cooking.

Pastries and oven food

General information

- We recommend using the accessories of the product for a good cooking performance. If you are going to use an external cookware, prefer dark, non-sticking and heat resistant ware.

- If preheating is recommended in the cooking table, be sure to put your food in the oven after preheating.
- If you are going to cook using cookware on the wire grill, place it in the middle of the wire grill, not near the back wall.
- All materials used in making pastry should be fresh and at room temperature.
- The cooking status of the products may vary depending on the amount of food and the size of the cookware.
- The values specified in the cooking tables are determined as a result of the tests carried out in our laboratories. Values suitable for you may differ from these values.
- Place your food on the appropriate shelf recommended in the cooking table. Refer to the bottom shelf of the oven as shelf 1.
- If it is cooked well inside but the outside is sticky, use a smaller amount of liquid, reduce the temperature and increase the cooking time.

Tips for cooking pastries

- If the pastry is too dry, increase the temperature by 10 ° C and shorten the cooking time. Wet the dough sheets with a sauce consisting of milk, oil, egg and yoghurt mixture.
 - If the pastry is getting cooked slowly, make sure that the thickness of the pastry you have prepared does not overflow the tray.
 - If the pastry is browned on the surface but the bottom is not cooked, make sure that the amount of sauce you will use for the pastry is not too much at the bottom of the pastry. For an even browning, try to spread the sauce evenly between the dough sheets and the pastry.
 - Bake your pastry in the position and temperature appropriate to the cooking table. If the bottom is still not browned enough, place it on a bottom shelf for the next cooking.
- ### **Tips for baking cakes**
- If the cake is too dry, increase the temperature by 10°C and shorten the baking time.
 - If the cake is moist, use a small amount of liquid or reduce the temperature by 10°C.
 - If the top of the cake is burnt, put it on the lower shelf, lower the temperature and increase the baking time.

Cooking table for pastries and oven food

Food	Tray amount	Accessory to be used	Operating function	Shelf position	Temperature (°C)	Cooking time (approx. in min.)
Cakes in tray	Single tray	Standard tray*	Fan heating	3	180	30 - 40
Cakes in mould	Single tray	Cake mould on wire grill**	Fan heating	2	180	30 - 40
Small cakes***	Single tray	Standard tray*	Fan heating	2	150	25 - 35
	2 trays	2 – Standard tray* 4 – Pastry tray*	Fan heating	2 - 4	140	30 - 45
Sponge cake***	Single tray	Round cake mould, 26cm in diameter with clamp on wire grill**	Fan heating	2	160	30 - 40
Cookie	Single tray	Pastry tray*	Fan heating	3	170	20 - 30
	2 trays	2 – Standard tray* 4 – Pastry tray*	Fan heating	2 - 4	170	25 - 35
Dough pastry	Single tray	Standard tray*	Fan heating	2	180	35 - 45
	2 trays	1 – Standard tray* 4 – Pastry tray*	Fan heating	1 - 4	180	35 - 45
Rich pastry	Single tray	Standard tray*	Fan heating	3	180	20 - 30
	2 trays	2 – Standard tray* 4 – Pastry tray*	Fan heating	2 - 4	180	20 - 30
Whole bread	Single tray	Standard tray*	Fan heating	3	200	30 - 40
Lasagna	Single tray	Glass/metal rectangular mould on wire grill**	Fan heating	2 or 3	200	30 - 40
Apple pie***	Single tray	Round black metal mould, 20cm in diameter on wire grill**	Fan heating	2	170	50 - 70
Pizza	Single tray	Standard tray*	Fan heating	2	200 - 220	10 - 20
Shortbread (sweet cookie)***	Single tray	Standard tray*	Fan heating	2	140	15 - 25
	2 trays	2 – Standard tray* 4 – Pastry tray*	Fan heating	2 - 4	140	15 - 25

Preheating is recommended for all food.

* These accessories may not be included with your product. They can be purchased commercially.

** These accessories are not included with your product. They are commercially available accessories.

*** **Test Foods** - Foods in this cooking table are prepared according to the EN 60350-1 standard to facilitate testing of the product for control institutes.

Meat, fish and poultry

The key points on roasting

- Seasoning it with lemon juice and pepper before cooking all chicken, turkey and large pieces of meat will increase cooking performance.
- It takes 15 to 30 minutes more to cook boned meat than fillet by roasting.
- You should calculate about 4 to 5 minutes of cooking time per centimetre of the meat thickness.
- After the cooking time is over, leave the meat in the oven for about 10 minutes. The juice of the meat is better distributed to the fried meat and does not come out when the meat is cut.
- Fish should be placed on a medium or low level shelf in a heat resistant plate.

Cooking table for meat, fish and poultry

Food	Tray amount	Accessory to be used	Operating function	Shelf position	Temperature (°C)	Cooking time (approx. in min.)
Steak (whole) / Roast (1kg)	Single tray	Standard tray*	Fan heating	3	15 mins. 250/max. then, 180 - 190	60 - 80
Lamb's shank (1.5 - 2.0kg)	Single tray	Standard tray*	Fan heating	3	15 mins. 250/max. then, 170	110 - 120
Roasted chicken (1.8 - 2kg)	Single tray	Wire grill* Place one tray on a lower shelf	Fan heating	2	200 - 200	60 - 80
Turkey (5.5kg)	Single tray	Standard tray*	Fan heating	1	25 mins. 250/max. then, 180 - 190	150 - 210
Fish	Single tray	Wire grill* Place one tray on a lower shelf	Fan heating	3	200	20 - 30

Preheating is recommended for all food.

* These accessories may not be included with your product. They can be purchased commercially.

** These accessories are not included with your product. They are commercially available accessories.

Grill

Red meat, fish and poultry meat will quickly turn brown when grilled, hold a beautiful crust and do not dry out. Fillet meats, skewer meats, sausages as well as juicy vegetables (tomatoes, onions, etc.) are particularly suitable for grilling.

General warnings

- Food not suitable for grilling carries a fire hazard. Grill only food that is suitable for heavy grill fire. Also, do not place the food too far in the back of the grill. This is the hottest area and fatty foods may catch fire.
- **Close the oven door during grilling. Never grill with the oven door open. Hot surfaces may cause burns!**

The key points of the grill

- Prepare foods of similar thickness and weight as much as possible for the grill.
- Place the pieces to be grilled on the wire grill or wire grill tray by distributing them without exceeding the dimensions of the heater.
- Depending on the thickness of the pieces to be grilled, the cooking times given in the table may vary.
- Slide the wire grill or the wire grill tray to the desired level in the oven. If you are cooking on the wire grill, slide the oven tray to the lower shelf to collect the oils. The oven tray you are going to slide should be sized to cover the entire grill area. This tray may not be included with the product. Put some water into the oven tray for easy cleaning.

Cooking table for grilling

Food	Accessory to be used	Shelf position	Temperature (°C)	Cooking time (approx. in min.)
Fish	Wire grill	4 - 5	250	20 - 25
Chicken pieces	Wire grill	4 - 5	250	25 - 35
Meatball (beef) 12 pieces*	Wire grill	4	250	20 - 30
Lamb chop	Wire grill	4 - 5	250	20 - 25
Steak - (sliced)	Wire grill	4 - 5	250	25 - 30
Veal chop	Wire grill	4 - 5	250	25 - 30
Vegetable gratin	Wire grill	4 - 5	220	20 - 30
Toast bread*	Wire grill	4	250	1 - 3

It is recommended to preheat for 5 minutes for all grilled food.

Turn pieces of food after 1/2 of the total grilling time.

* **Grilling for test foods** - Foods in this cooking table are prepared according to the EN 60350-1 standard to facilitate testing of the product for control institutes.

7. Maintenance and care

General cleaning information

General warnings

- Wait for the product to cool before cleaning the product. Hot surfaces may cause burns!
- Do not apply the detergents directly on the hot surfaces. This may cause permanent stains.
- The appliance shall be thoroughly cleaned and dried after each operation. Thus, food residues shall be easily cleaned and these residues shall be prevented from burning when the appliance is used again later. Thus, the service life of the appliance extends and frequently faced problems are decreased.
- Do not use steam cleaning products for cleaning.
- Some detergents or cleaning agents may damage the surface. Do not use abrasive detergents, cleaning powders, cleaning creams, descalers or sharp objects during cleaning.
- There is no need for a special cleaning agent for cleaning after each use. Clean the appliance using dish soap, warm water and a soft cloth or sponge and dry with a dry microfibre cloth.
- Be sure to completely wipe off any remaining liquid after

cleaning and immediately clean any food splashing around during cooking.

- Do not wash any component of your appliance in a dishwasher.

Inox and stainless surfaces

- Do not use acid or chlorine-containing cleaning agents to clean stainless or inox surfaces and handles.
- Stainless or inox surface may change colour in time. This is normal. After each operation, clean with a detergent suitable for the stainless or inox surface.
- Clean with a soft soapy cloth and liquid (non-scratching) detergent suitable for inox surfaces, taking care to wipe in one direction.
- Remove lime, oil, starch, milk and protein stains on the inox-stainless and glass surfaces immediately without waiting. Stains may rust under long periods of time.

Enamelled surfaces

- After each use, clean the enamel surfaces using dishwashing detergent, warm water and a soft cloth or sponge and dry them with a dry cloth.
- If your product has an easy steam cleaning function, you can make easy steam cleaning for light non-permanent dirt.

- For persistent stains, the oven and grill cleaner recommended on the website of your product brand and a non-scratching scouring pad can be used. Do not use an external oven cleaner.
- The oven must cool down for cleaning in the cooking area. Cleaning on hot surfaces shall create both fire hazard and damage with enamel surface.
- If there is residual detergent after cleaning, wipe it with cold water and dry with a clean and dry microfibre cloth. Residual detergent residue may damage the glass surface next time.
- Under no circumstances should the dried-up residue on the glass surface be cleaned off with serrated knives, wire wool or similar scratching tools.

Catalytic surfaces

- The side walls in the cooking area can only be covered with enamel or catalytic walls. It varies by model.
- The catalytic walls have a light matte and porous surface. The catalytic walls of the oven should not be cleaned.
- Catalytic surfaces absorb oil thanks to its porous structure and start to shine when the surface is saturated with oil, in this case it is recommended to replace the parts.

Glass surfaces

- When cleaning glass surfaces, do not use hard metal scrapers and abrasive cleaning materials. They can damage the glass surface.
- Clean the appliance using dishwashing detergent, warm water and a microfibre cloth specific for glass surfaces and dry it with a dry microfibre cloth.

- You can remove the calcium stains (yellow stains) on the glass surface with the commercially available descaling agent, with a descaling agent such as vinegar or lemon juice.
- If the surface is heavily soiled, apply the cleaning agent on the stain with a sponge and wait a long time for it to work properly. Then clean the glass surface with a wet cloth.
- Discolourations and stains on the glass surface are normal and not defects.

Plastic parts and painted surfaces

- Clean plastic parts and painted surfaces using dishwashing detergent, warm water and a soft cloth or sponge and dry them with a dry cloth.
- Do not use hard metal scrapers and abrasive cleaners. It may damage the surfaces.
- Ensure that the joints of the components of the appliance are not left as damp and with detergent. Otherwise, corrosion may occur on these joints.

Cleaning the accessories

Unless otherwise stated in the user manual, do not wash the product accessories in the dishwasher.

Cleaning the control panel

- When cleaning the panels with knob control, wipe the panel and knobs with a damp soft cloth and dry with a dry cloth. Do not remove the knobs and gaskets underneath to clean the control panel. The control panel and knobs may be damaged.
- While cleaning the inox panels with knob control, do not use inox cleaning agents around the knobs. The indicators around the knobs may be deleted.
- Clean the touch control panels with a damp soft cloth and dry with a dry cloth. If your product has a key lock feature, set the key lock before performing control panel cleaning. Otherwise, incorrect detection may occur on the keys.

Cleaning the inside of the oven (cooking area)

Follow the cleaning steps described in the “General cleaning information” section according to the surface types in your oven.

Cleaning the side walls of the oven

The side walls in the cooking area can only be covered with enamel or catalytic walls. It varies by model. If there is a catalytic wall, refer to the “Catalytic walls” section for information.

If your product is a side rack model, remove the side racks before cleaning your side walls. Then complete the cleaning as described in the “General cleaning information” section according to the side wall surface type.

Cleaning the oven door

-  Do not use harsh abrasive cleaners, metal scrapers, wire wool or bleach materials to clean the oven door and glass.

You can remove your oven door and door glasses to clean them. How to remove the doors and windows is explained in the sections “Removing the oven door” and “Removing the inner glass of the door”. After removing the door inner glasses, clean them using a dishwashing detergent, warm water and a soft cloth or sponge and dry them with a dry cloth. Wipe the glass with vinegar and then rinse it against lime residues that may occur on the oven glass.

Removing the oven door

1. Open the front door.
2. Open the clips at the hinge housing on the right and left hand sides of the front door by pressing them down as illustrated in the figure.

Hinge lock (closed position)

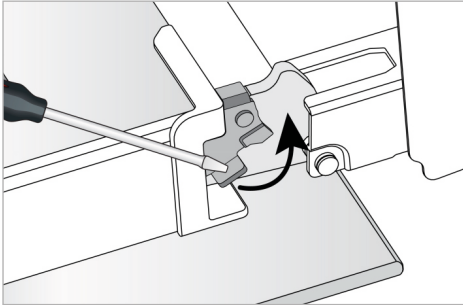

Hinge lock (open position)

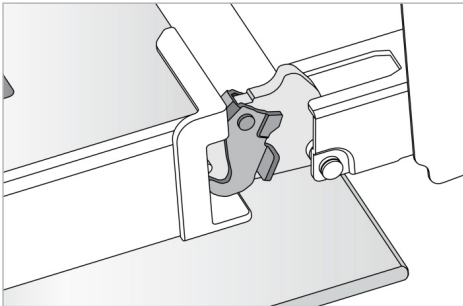

3. Get the oven door to a half-open position.

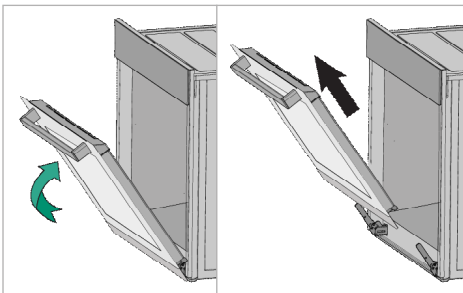

4. Pull the removed door upwards to release it from the right and left hinges and remove it.

i To reattach the door, the procedures applied when removing it must be repeated from the end to the beginning, respectively. When installing the door, be sure to close the clips on the hinge socket.

Removing the inner glass of the oven door

Inner glass of the product's front door of may be removed for cleaning.

1. Open the oven door.

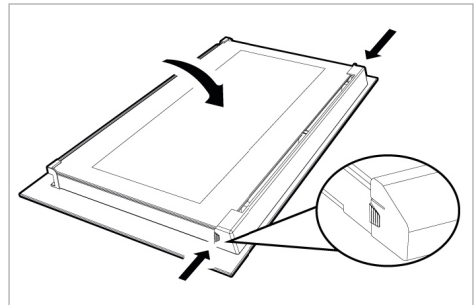

2. Pull the plastic component, attached on the upper section of the front door, towards yourself by simultaneously pressing on the pressure points on both sides of the component and remove it.

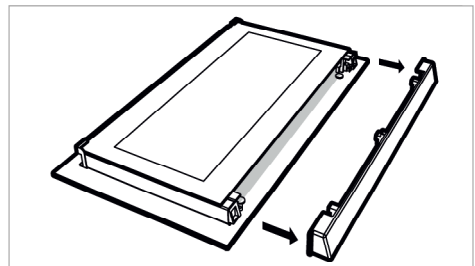

3. As shown in the figure, gently lift the innermost glass **1** towards **A** and then, remove it by pulling towards **B**.

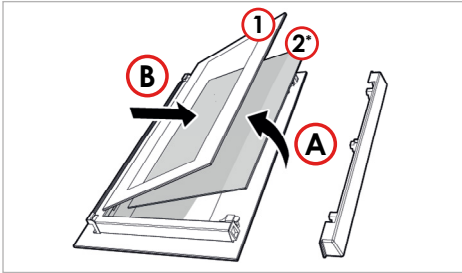

1. Innermost glass panel.
- 2* Inner glass panel (It may not exist on your product.)
4. If your product has an inner glass **2**, repeat the same process to detach it **2**.
5. The first step of regrouping the door is to reassemble the inner glass **2**. Place the bevelled edge of the glass to meet the bevelled edge of the plastic slot. (If your product has an inner glass). Inner glass **2** must be attached to the plastic slot closest to the innermost glass **1**.
6. While reassembling the innermost glass **1**, pay attention to place the printed side of the glass on the inner glass. It is crucial to place the lower corners of the innermost glass **1** to meet the lower plastic slots.
7. Push the plastic component towards the frame until a 'click' sound is heard.

Cleaning the oven lamp

In the event that the glass door of the oven lamp in the cooking area becomes dirty; clean using dishwashing detergent, warm water and a soft cloth or sponge and dry with a dry cloth. In case of oven lamp failure, you can replace the oven lamp by following the sections that follow.

Replacing the oven lamp

⚠ General warnings

- To avoid the risk of an electric shock before replacing the oven lamp, disconnect the electrical connector and wait for the oven to cool. Hot surfaces may cause burns!
- The oven lamp is a special electric bulb resistant to 300°C. Oven lamps can be obtained from Authorised Services.
- The position of the lamp may differ from that is shown in the figure.
- The lamp used in this product is not suitable for use in the lighting of home rooms. The purpose of this lamp is to help the user see food products.
- The lamps used in this product must withstand extreme physical conditions such as temperatures above 50°C.

If your oven has a round lamp

1. Disconnect the product from the electricity.
2. Remove the glass cover by turning it counterclockwise.

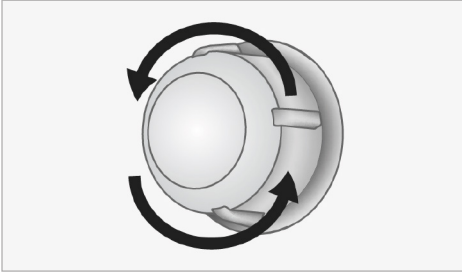

3. If your oven lamp is type **A** shown in the figure below, rotate the oven lamp as shown in the figure and replace it with a new one. If type **B** is a model, pull it out as shown in the figure and replace it with a new one.

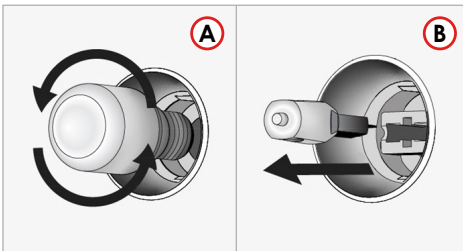

4. Refit the glass cover.

8. Troubleshooting

Consult the Authorised Service Agent or technician with license or the dealer where you have purchased the product if you cannot remedy the trouble although you have implemented the instructions in this section. Never attempt to repair a defective product yourself.

Oven emits steam when it is in use

- It is normal that steam escapes during operation. »» *This is not a fault.*

Water drops occur during cooking

- The vapour that arises during cooking can condense and form water droplets when it hits cold surfaces of the product. »» *This is not a fault.*

Product emits metal noises while heating and cooling

- When the metal parts are heated, they may expand and cause noise.
»» *This is not a fault.*

Product does not operate

- The mains fuse is defective or has tripped. »» *Check fuses in the fuse box. If necessary, replace or reset them.*
- Product is not wired into the (grounded) socket. »» *Check the electrical connection.*
- Buttons/knobs/keys on the control panel do not function. »» *If your product is equipped with key lock function, key lock may be enabled. Please disable it.*

Oven light does not work

- Oven lamp is defective. »» *Replace oven lamp.*
- Power is cut. »» *Check if there is power. Check the fuses in the fuse box. If necessary, replace or reset the fuses.*

Oven does not heat

- Might not be set to a certain cooking function and/or temperature. »» *Set the oven to a certain cooking function and/or temperature.*
- Power is cut. »» *Check if there is power. Check the fuses in the fuse box. If necessary, replace or reset the fuses.*

9. Your guarantee

Product Guarantee Details (UK and Republic of Ireland only)

Your appliance has the benefit of a comprehensive manufacturer's guarantee which covers the cost of breakdown repairs. (Details of which are shown on your Proof of Purchase Document).

- Any claim during the period of the guarantee **MUST BE ACCOMPANIED BY THE PROOF OF PURCHASE.**
- The product must be correctly installed and operated in accordance with the manufacturer's instructions and used for normal domestic purposes.
- This guarantee does not cover accidental damage, misuse or alterations which are likely to affect the product.
- The guarantee is invalid if the product is tampered with, or repaired by any unauthorised person. *(The guarantee in no way affects your statutory or legal rights).*

What to do if you need to report a problem

Please ensure you have ready:

- The product's model and serial numbers.
- Howdens Proof of Purchase Document.
- Your full contact details.

Call the Depot number on your Proof of Purchase Document supplied with the product/kitchen.

or

Call the LAMONA Service Line on:

Within the UK: 0344 460 0006

Within Republic of Ireland: 01525 5703

- Product installed within a domestic kitchen or a non-domestic kitchen where 8 or fewer people are using the appliance.

Where to find model and serial number on your appliance.	Open door on panel just below door seal.
--	--

Spare Parts availability – 10 years

Only fit Genuine Spare Parts

www.lamonaspares.co.uk (UK only)

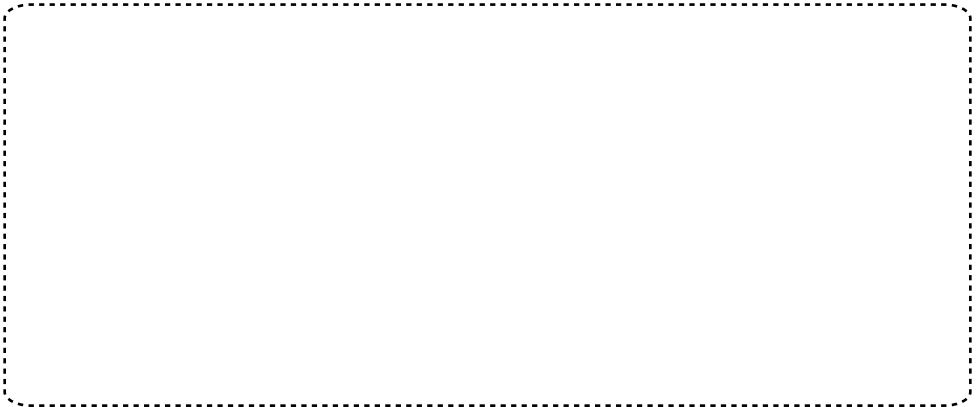

Product serial number
(Place sticker here)

LAMONA

at the heart of the kitchen



FR

Cet appareil
se recycle

REPRISE
À LA LIVRAISON



OU

À DÉPOSER
EN MAGASIN



OU

À DÉPOSER
EN DÉCHÈTERIE



Points de collecte sur www.quefairedemesdechets.fr
Privilégiez la réparation ou le don de votre appareil!

Howden Joinery Ltd, Thorpe Road, Howden, East Yorkshire, DN14 7PA

Imported in EU by: Houdan Cuisines SAS, Z.A. du Bois Rigault Nord,
1Rue Calmette, 62880 Vendin-le-Vieil, Cedex, France.

Product information correct at the time of publication in March 2022.
The company has a policy of continuous product development and
reserves the right to change any products and specifications given in
this manual. Subject to the Terms and Conditions of Trading, a copy of
the Howdens Terms and Conditions is available upon request.

Copyright © 2022 Howden Joinery Ltd. All rights reserved.